

PROPOSED SITE PLAN
(LANDSCAPE AND PARKING)
SCALE=1:200

AREA STATEMENT		VERSION NO. 1.0.04	VERSION DATE 01/12/2025	
PROJECT DETAIL:				
Authority	Private Development Authority	Plot Use	Residential	
Authority Class	Category B	Plot Sub-Use	Group Housing	
Authority Grade	Development Authority (DA)	Development Plan	Master Plan	
Case Type	Regular	Land Use Zone	Residential use Zone	
Project Type	Group Development	Land Sub-Use Zone	Residential Zone	
Nature of Development	NEW	Layout Type	NA	
CaseType	Revision			
Development Area	Undeveloped Area			
Sub-Development Area	Metro City Area			
Special Project	NA			
Site Address	District Prayagraj, Tehsil Phulpur, Mauja Maheshpur, Village NA			
AREA DETAILS:				
1. Area of Plot As per record	Sq.Mts.			
Document Area	9510.00			
As per site condition	9510.00			
Area of Plot Considered	9510.00			
2. Deduction for				
(a) Proposed roads	0.00			
Curtilage Area of Well	0.00			
(b) Any reservations				
(c) Area of Plot (1 - 2) AREA OF PLOT	0.00			
3. Net Area of plot (1 - 2) AREA OF PLOT	9510.00			
Plot Area For Coverage	9510.00			
Plot Area For FAR	9510.00			
(a) Perm. FAR Area (2.50)	23775.00			
(b) Incentive FAR against EWS and LIG	1501.50			
Max. Permissible Paid FAR (50% of basic FAR)	11887.50			
Total Permissible FAR (3.91)	37164.00			
Proposed Paid FAR	9693.27			
Total Built up area permissible at:				
Permissible Coverage area (40.83%)	NA			
Proposed Coverage Area (40.83%)	3883.50			
Proposed FAR at:				
	Proposed Built up	Existing Built up	Proposed FAR	Paid FAR
Basement Floor	5447.83	0.00	0.00	0.00
0th Floor	3387.78	0.00	0.00	0.00
Ground Floor	495.77	0.00	184.38	0.00
First Floor	3427.71	0.00	2986.79	0.00
Second Floor	2522.03	0.00	2182.41	0.00
Third Floor	2998.88	0.00	2182.41	0.00
Fourth Floor	2998.88	0.00	2182.41	0.00
Fifth Floor	2998.88	0.00	2182.41	0.00
Sixth Floor	2998.88	0.00	2182.41	0.00
Seventh Floor	2998.88	0.00	2182.41	0.00
Eighth Floor	2998.88	0.00	2182.41	0.00
Ninth Floor	2998.88	0.00	2182.41	0.00
Tenth Floor	2998.88	0.00	2182.41	0.00
Eleventh Floor	2998.88	0.00	2184.60	0.00
Twelfth Floor	2998.88	0.00	2174.37	1275.33
Thirteenth Floor	2998.88	0.00	2184.60	2184.60
Fourteenth Floor	2998.88	0.00	2174.37	2174.37
Fifteenth Floor	2998.88	0.00	2184.60	2184.60
Sixteenth Floor	2998.88	0.00	2174.37	2174.37
Terrace Floor	248.90	0.00	0.00	0.00
Total Area	58244.04	0.00	35269.77	9693.27
Total FAR Area				35269.77
Total Built up Area:				58244.04
Proposed FAR consumed:				3.71
Termination Statement				
A. Termination Proposed At:				
All Floors			231	
B. Total Tenements (3 x 4)				
			231	
Tree Details (Table 3h)				
Plot	Name	No. of Trees	Prop.	
	Tree	48	58	

Required Parking (Table 7a)

Building Name	Type	Sub-Use	Area (Sq.Mt.)	Units	Car	Reqd.	Prop.	Walkers Car	Reqd.	Total ECS
A (DH)	Residential	Group Housing	> 50-100	98	1.00	98	-	-	-	-
			> 100-150	135	1.25	169	-	-	-	-
Total				231	-	265	10%	23	288	334

Vehicle Type	Prop. Parking	No.	ECS
Car Parking	258	258	
Two Wheeler	304	76	
Total		334	

Green and open space Area

Name	Reqd. Area	Prop. Area
Green Area	910.50	981.96



OWNER'S NAME AND SIGNATURE
 OWNERS:-
 1. DR. SHEO PRATAP SINGH S/O LATE BRAMH DEV SINGH
 2. MR. RAHUL SINGH S/O DR. SHEO PRATAP
 3. MR. RISHI SINGH S/O DR. SHEO PRATAP
 DEVELOPER:-
 CITIZEN INFRAVENTURES PRIVATE LIMITED THROUGH DIRECTOR
 MR. ANUBHAV VERMA.

ARCHITECT'S NAME AND SIGNATURE
 STRUCTURE ENGINEER
 AKHILESHWAR SINGH
 CA/1994/16740

Building Plan Application Number
 Sanctioned On
 Valid Till
 Approved By
 Examined By

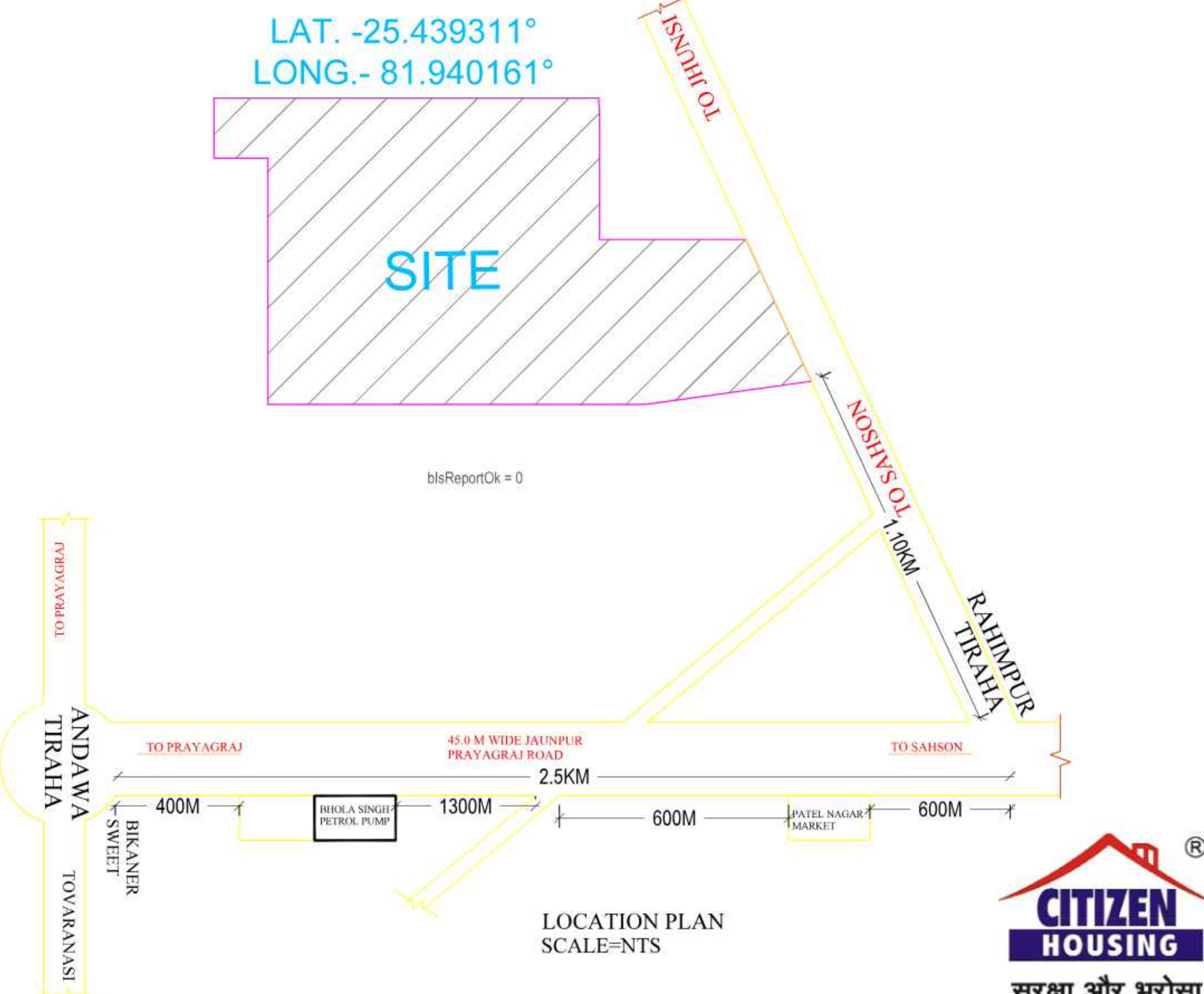
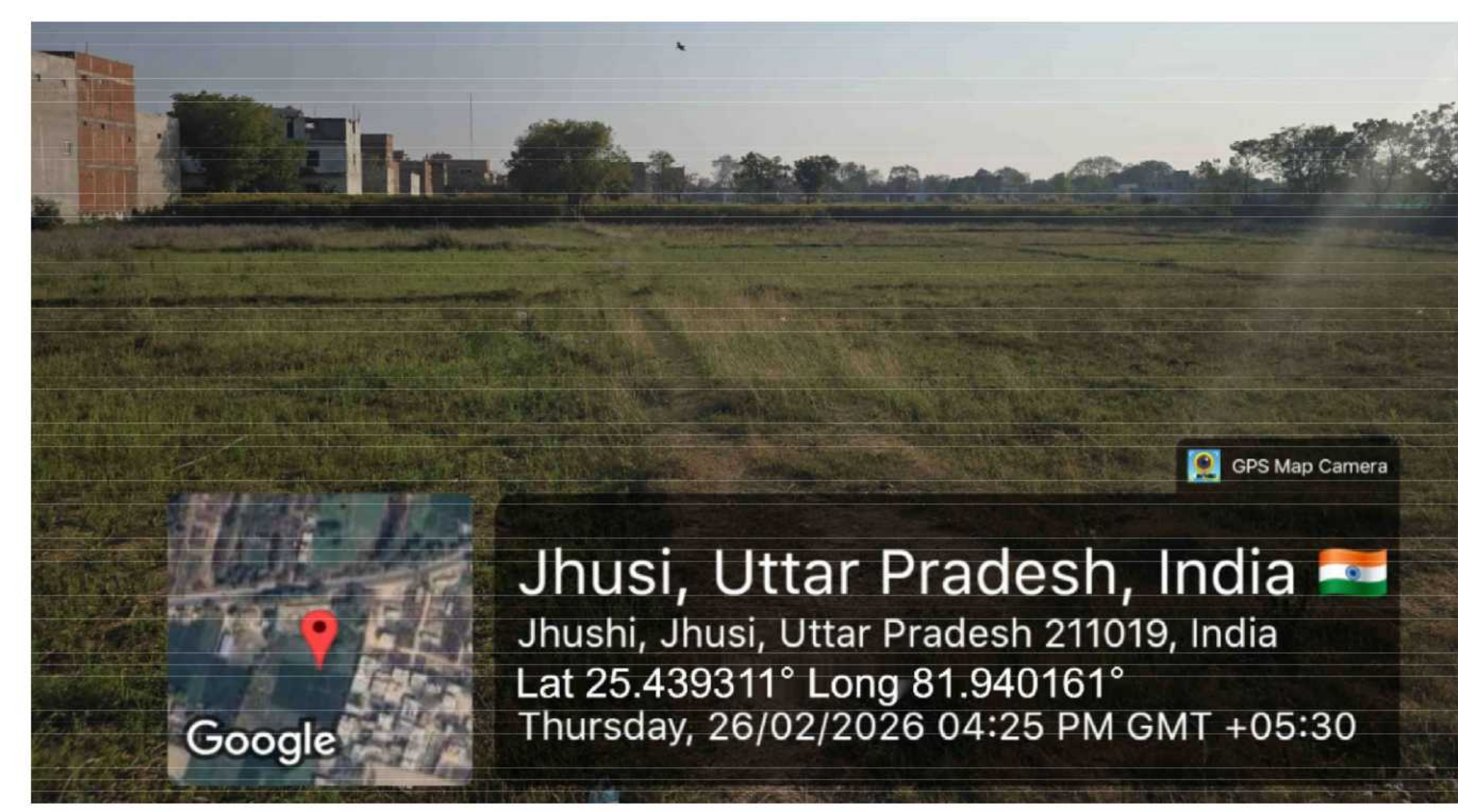
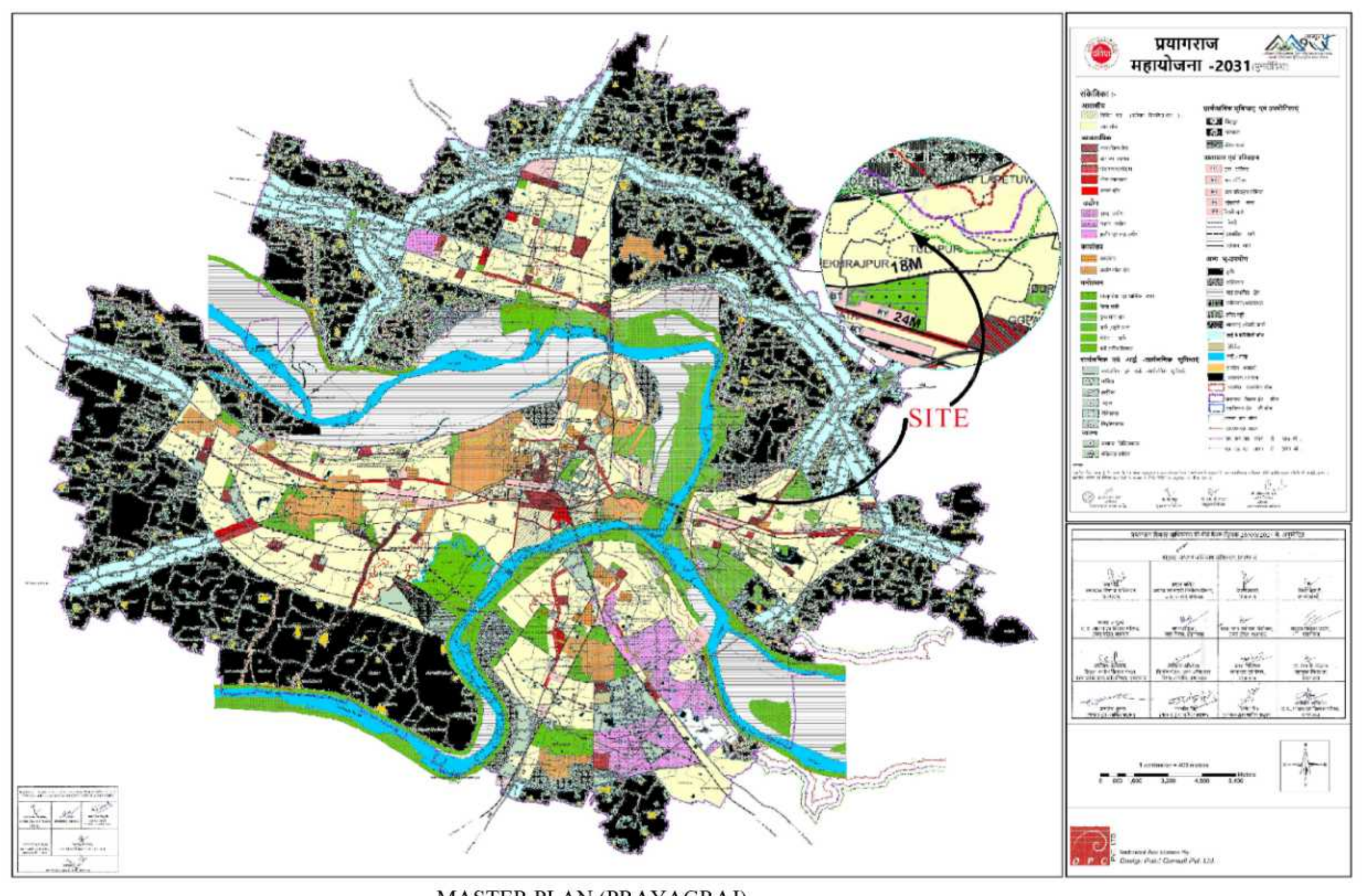

Total Plot Area :-	9510.00	Total FAR Area :-	35269.77
Total Coverage Area :-	3883.50	Total BUA Area :-	58244.04

Note: - 1) This drawing is prepared as per the current prevailing Building Bye Laws.
 2) If Map sanctioned is used for purpose anything other than stated in application will lead to rejection of Map.

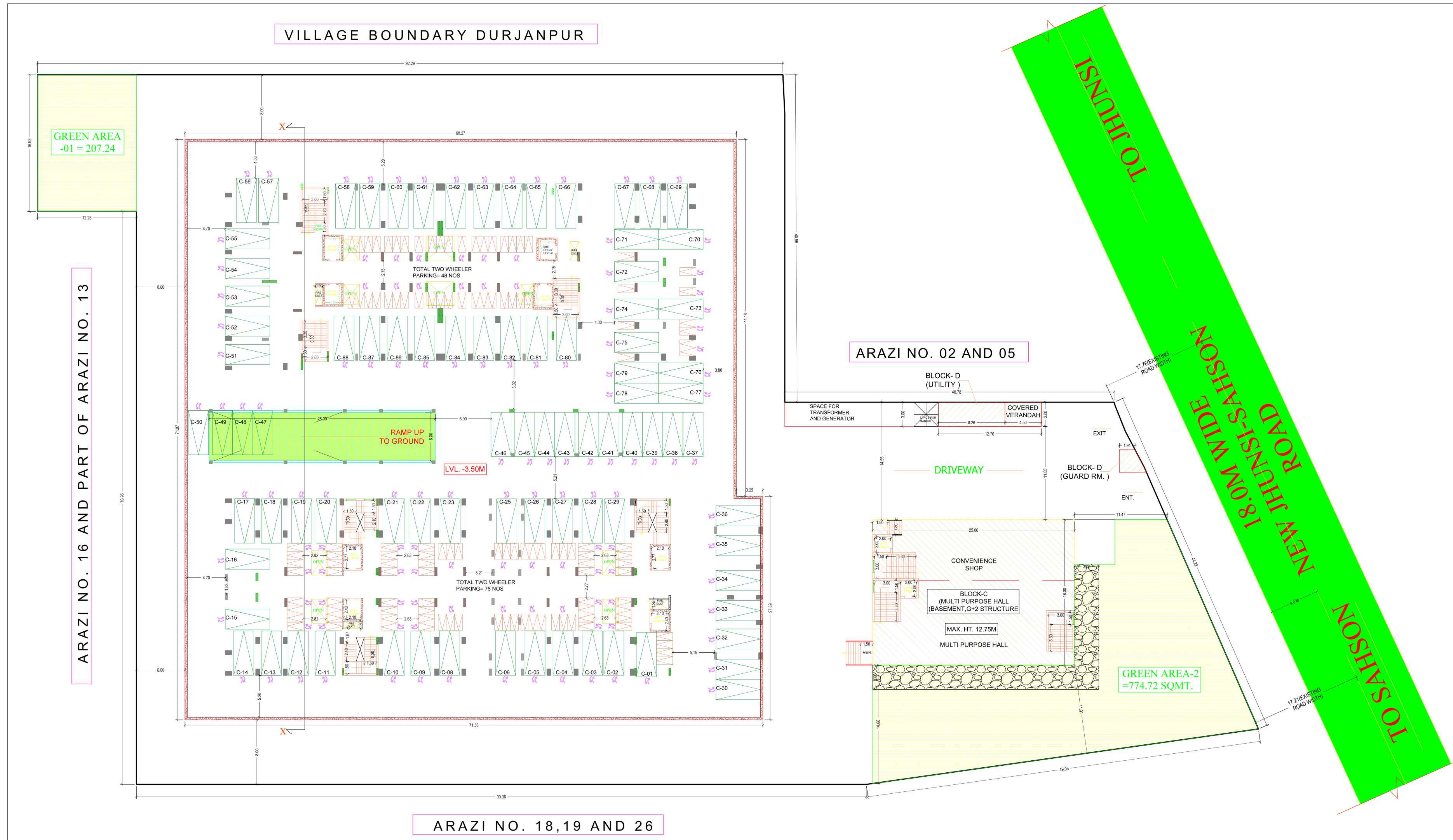

ARAZI NO. 18, 19 AND 26

PROPOSED BASEMENT FLOOR PLAN (PARKING) (BLOCK-A&B) SCALE=1:200

Building USE/SUBUSE Details Block A&B

Building Name	Building Use	Building Sub-Use	Building Use Group	Building Type	Building Structure	No Of Residential Units	Floor Name	Floor Use	Floor Sub-Use	FAR Name	FAR Use	FAR Sub-Use
A & B	Residential	Group Housing	-	Highrise	-	231	BASEMENT FLOOR PLAN	Parking	Parking	-	-	-
							STILT FLOOR PLAN	Parking	Parking	-	-	-
							FIRST FLOOR PLAN	Residential	Group Housing	Residential FAR	Residential	Residential
							TYPICAL 2-30 FLOOR PLAN	Residential	Group Housing	Residential FAR	Residential	Residential
							TYPICAL 11,13,15 FLOOR PLAN	Residential	Group Housing	Residential FAR	Residential	Residential
							TYPICAL 12,14,16 FLOOR PLAN	Residential	Group Housing	Residential FAR	Residential	Residential
TERRACE FLOOR PLAN	Residential	Group Housing	-	-	-							

Note: - 1) This drawing is prepared as per the current prevailing Building Bye Laws.
 2) If Map sanctioned is used for purpose anything other than stated in application will lead to rejection of Map.



OWNER'S NAME AND SIGNATURE
 OWNERS:-
 1. DR. SHEO PRATAP SINGH S/O LATE BRAMH DEV SINGH
 2. MR. RAHUL SINGH S/O DR. SHEO PRATAP
 3. MR. ROHIT SINGH S/O DR. SHEO PRATAP
 DEVELOPER:-
 CITIZEN INFRAVENTURES PRIVATE LIMITED THROUGH DIRECTOR
 MR. ANUSHKA VERMA.

ARCHITECT'S NAME AND SIGNATURE | STRUCTURE ENGINEER
 AKHILESHWAR SINGH
 CA/1994/16740

Prayagraj Development Authority

Building Plan Application Number

Sanctioned On

Valid Till

Approved By

Examined By



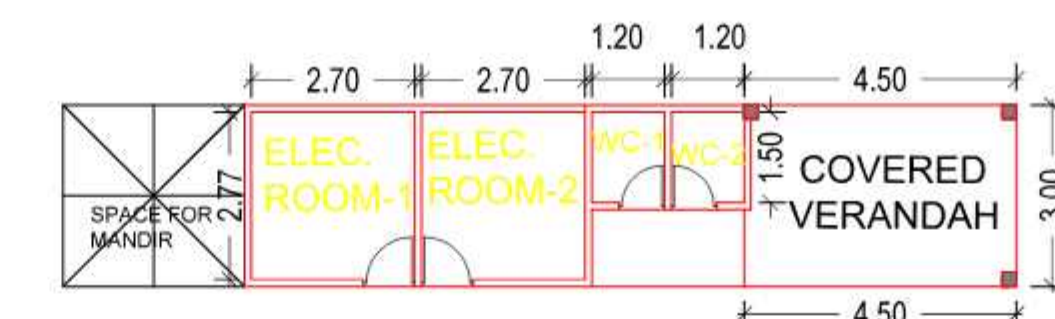
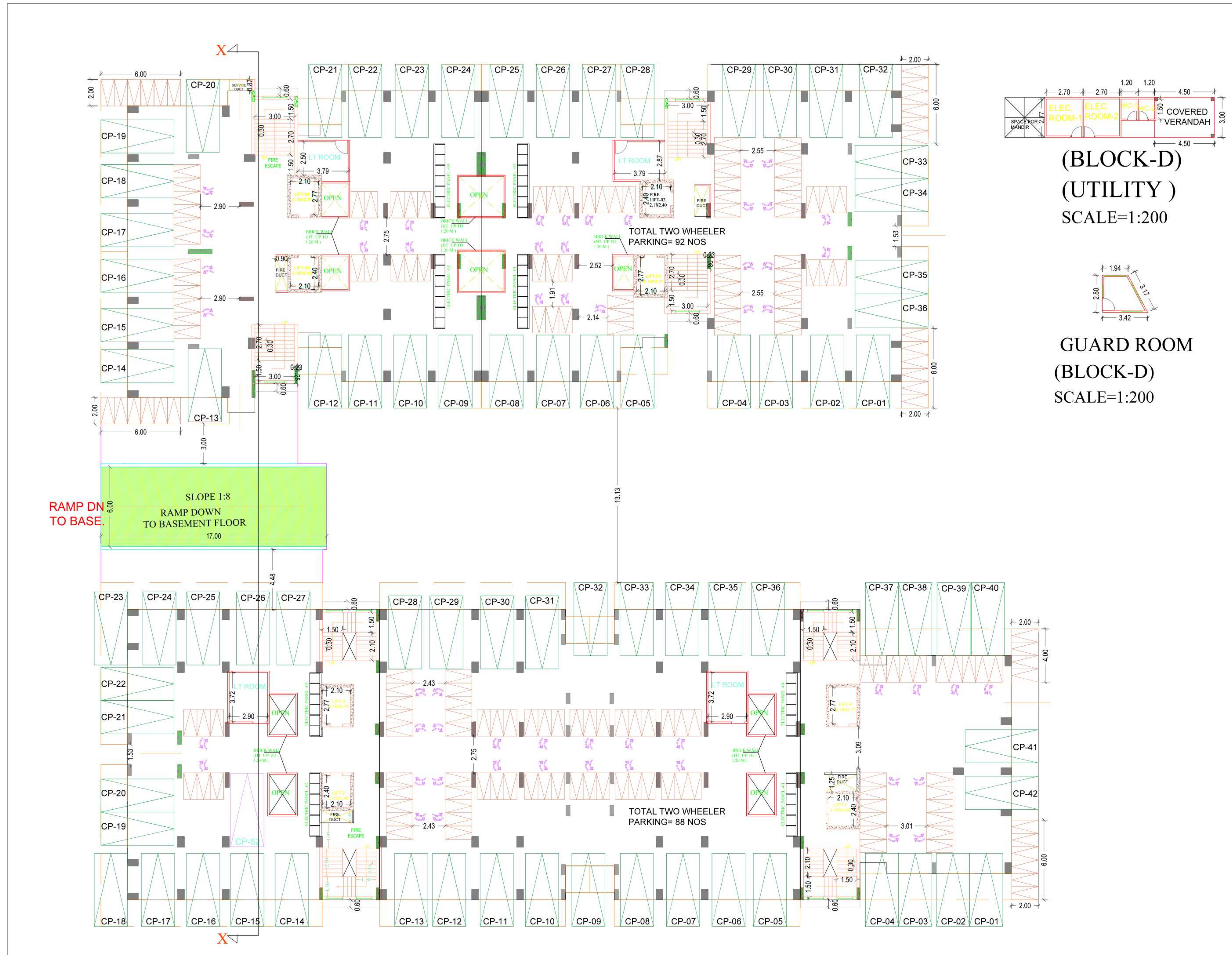

(BLOCK-D)
 (UTILITY)
 SCALE=1:200

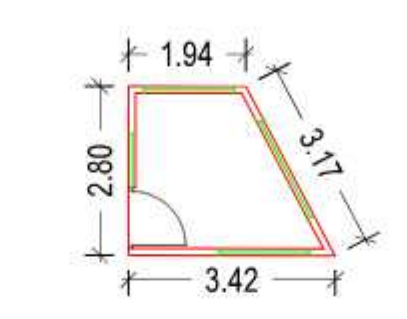

GUARD ROOM
 (BLOCK-D)
 SCALE=1:200

PROPOSED GROUND FLOOR PLAN (STILT PARKING)
 (BLOCK=A&B)
 SCALE=1:200

SCHEDULE OF WINDOW/VENTILATION:

BUILDING NAME	NAME	LENGTH	HEIGHT	NOS
A (GH)	VENT1	0.60	1.00	224
A (GH)	KWT.2	1.20	2.75	111
A (GH)	SDT.6	1.60	2.75	140
A (GH)	SDT.8	1.80	2.75	188

SCHEDULE OF DOOR:

BUILDING NAME	NAME	LENGTH	HEIGHT	NOS
A (GH)	D.75	0.75	2.10	232
A (GH)	FIRE DOOR	0.90	2.10	08
A (GH)	E1	1.00	2.10	327
A (GH)	KD1.1	1.10	2.10	109
A (GH)	SD1.8	1.80	2.75	14

Additional Permissible FAR

Total Permissible FAR	Available FAR	5% Additional FAR	Total Proposed FAR	Balance FAR
37184.00	35269.77	1763.48	1720.92	42.58

Additional Permissible FAR

Area covered under FAR Area	Proposed Area	Total Proposed Area
Community Facility	682.00	1720.92
Lift Lobby	462.36	
MURMITY	192.54	
Lift Machine Room	66.30	
Wardrobe	327.86	

Area Details for Building :A.B

Floor Name	Block Name	Gross Builtup Area	Deductions From Gross BUA/Area in Sq.m	Total Built Up Area (Sq.m)	Deductions (Area in Sq.m)										Total FAR Area (Sq.m)	No. of Unit		
					Fireescape	Lift	Lift Machine	Lift Lobby	Murmy	Wardrobe	Balcony	Accessory Use	Ramp	Parking				
Basement Floor	A+B	4997.83	0.00	4997.83	40.65	43.38	0.00	0.00	0.00	0.00	0.00	0.00	0.00	0.00	168.00	4745.80	0.00	00
Site Floor	A+B+D	3433.53	0.00	3433.53	73.12	0.00	0.00	0.00	0.00	0.00	0.00	0.00	0.00	67.07	192.00	3191.34	0.00	00
First Floor	A	1490.12	71.86	1418.26	45.08	21.71	0.00	10.88	0.00	11.89	300.07	0.00	0.00	0.00	0.00	1028.63	08	
	B	1679.61	99.01	1580.60	63.70	21.71	0.00	11.52	0.00	9.41	320.48	0.00	0.00	0.00	0.00	1153.78	07	
TOTAL		3168.73	170.87	2998.86	108.78	43.42	0.00	22.40	0.00	21.30	620.55	0.00	0.00	0.00	2182.41	15		
Typical 2-10th Floor	A	1490.12	71.86	1418.26	45.08	21.71	0.00	10.88	0.00	11.89	300.07	0.00	0.00	0.00	0.00	1028.63	08	
	B	1679.61	99.01	1580.60	63.70	21.71	0.00	11.52	0.00	9.41	320.48	0.00	0.00	0.00	0.00	1153.78	07	
TOTAL PER FLOOR		3168.73	170.87	2998.86	108.78	43.42	0.00	22.40	0.00	21.30	620.55	0.00	0.00	0.00	2182.41	15		
TOTAL		28527.57	1537.83	26989.74	979.02	390.78	0.00	201.60	0.00	191.70	5584.95	0.00	0.00	0.00	0.00	19641.69	135	
Typical 11,13,16th Floor	A	1490.12	71.86	1418.26	45.08	21.71	0.00	10.88	0.00	11.89	300.07	0.00	0.00	0.00	0.00	1028.63	08	
	B	1679.61	99.01	1580.60	63.70	21.71	0.00	11.52	0.00	7.22	320.48	0.00	0.00	0.00	0.00	1155.97	07	
TOTAL PER FLOOR		3168.73	170.87	2998.86	108.78	43.42	0.00	22.40	0.00	19.11	620.55	0.00	0.00	0.00	2184.60	15		
TOTAL		9059.19	512.61	8546.58	326.34	130.26	0.00	67.20	0.00	57.33	1961.65	0.00	0.00	0.00	0.00	6953.90	43	
Typical 12,14,16th Floor	A	1490.12	71.86	1418.26	45.08	21.71	0.00	10.88	0.00	11.89	300.07	0.00	0.00	0.00	0.00	1028.63	08	
	B	1679.61	99.01	1580.60	63.70	21.71	0.00	11.52	0.00	7.22	320.71	0.00	0.00	0.00	0.00	1145.74	04	
TOTAL PER FLOOR		3168.73	170.87	2998.86	108.78	43.42	0.00	22.40	0.00	19.11	630.78	0.00	0.00	0.00	0.00	2174.37	12	
TOTAL		9059.19	512.61	8546.58	326.34	130.26	0.00	67.20	0.00	57.33	1892.34	0.00	0.00	0.00	0.00	6823.11	36	
Terrace Floor	A	147.94	48.80	99.14	0.00	0.00	31.18	0.00	67.98	0.00	0.00	0.00	0.00	0.00	0.00	0.00	00	
	B	181.49	78.08	103.41	0.00	0.00	31.18	0.00	72.23	0.00	0.00	0.00	0.00	0.00	0.00	0.00	00	
TOTAL		329.43	126.88	202.55	0.00	0.00	62.36	0.00	140.19	0.00	0.00	0.00	0.00	0.00	0.00	0.00	00	
Total Number of Same Buildings:	1	1																
Total		59476.47	2860.80	56615.67	1854.25	738.10	62.36	358.40	140.19	327.68	9659.49	67.07	270.00	7937.14	34901.01	231		



OWNER'S NAME AND SIGNATURE
 OWNERS:-
 1. DR. SHEO PRATAP SINGH S/O LATE BRAMH DEV SINGH
 2. MR. RAHUL SINGH S/O DR. SHEO PRATAP
 3. MR. ROHIT SINGH S/O DR. SHEO PRATAP
 DEVELOPER:-
 CITIZEN INFRAVENTURES PRIVATE LIMITED THROUGH DIRECTOR
 MR. ANUBHAV VERMA.

ARCHITECT'S NAME AND SIGNATURE STRUCTURE ENGINEER
 AKHILESHWAR SINGH
 CA/1994/16740

Prayagraj Development Authority

Building Plan Application Number

Sanctioned On

Valid Till

Approved By

Examined By



Note: - 1) This drawing is prepared as per the current prevailing Building Bye Laws.
 2) If Map sanctioned is used for purpose anything other than stated in application will lead to rejection of Map.

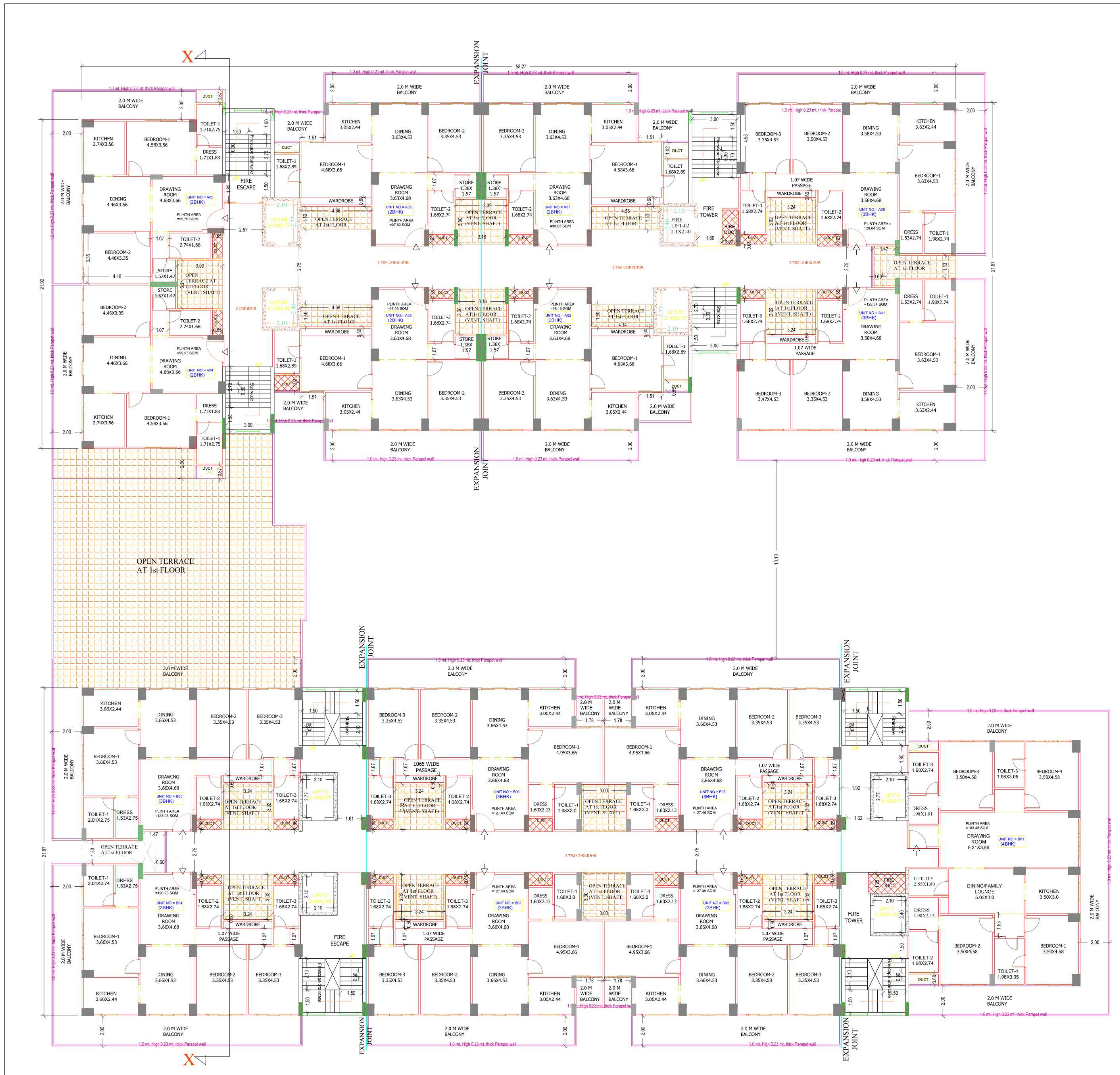

PROPOSED FIRST FLOOR PLAN (BLOCK-A&B)

Staircase Checks (Table 8a-1)

Floor Name	StairCase Name	Flight Width	Tread Width	Riser Height	Railing Ht.
BASEMENT FLOOR PLAN	STAIRCASE	1.50	0.30	0.130	1.00
	STAIRCASE	1.50	0.30	0.130	1.00
	STAIRCASE	1.50	0.30	0.130	1.00
STILT FLOOR PLAN	Fire Escape	1.50	0.30	0.130	1.00
	STAIRCASE	1.50	0.30	0.130	1.00
	STAIRCASE	1.50	0.30	0.130	1.00
FIRST FLOOR PLAN	STAIRCASE	1.50	0.30	0.130	1.00
	STAIRCASE	1.50	0.30	0.130	1.00
	STAIRCASE	1.50	0.30	0.130	1.00
TYPICAL 2-10 FLOOR PLAN	STAIRCASE	1.50	0.30	0.130	1.00
	STAIRCASE	1.50	0.30	0.130	1.00
	STAIRCASE	1.50	0.30	0.130	1.00
TYPICAL 11,13,15 FLOOR PLAN	STAIRCASE	1.50	0.30	0.130	1.00
	STAIRCASE	1.50	0.30	0.130	1.00
	STAIRCASE	1.50	0.30	0.130	1.00
TYPICAL 12,14,16 FLOOR PLAN	STAIRCASE	1.50	0.30	0.130	1.00
	STAIRCASE	1.50	0.30	0.130	1.00
	STAIRCASE	1.50	0.30	0.130	1.00
TERRACE FLOOR PLAN	STAIRCASE	1.50	0.30	0.130	1.00



Citizen Housing
TWIN TOWERS

OWNER'S NAME AND SIGNATURE
 OWNERS-
 1. DR. SHEO PRATAP SINGH S/O LATE BRAMH DEV SINGH
 2. MR. RAHUL SINGH S/O DR. SHEO PRATAP
 3. MR. ROHIT SINGH S/O DR. SHEO PRATAP
 DEVELOPER-
 CITIZEN INFRAVENTURES PRIVATE LIMITED THROUGH DIRECTOR
 MR. ANUBHAV VERMA.
 ARCHITECT'S NAME AND SIGNATURE STRUCTURE ENGINEER
 AKHESHWAR SINGH
 CA/1994/16740
 Prayagraj Development Authority
 Building Plan Application Number
 Sanctioned On
 Valid Till
 Approved By
 Examined By



Note: - 1) This drawing is prepared as per the current prevailing Building Bye Laws.
 2) If Map sanctioned is used for purpose anything other than stated in application will lead to rejection of Map.
 ISO_ND_(841.00_x_1189.00_MM)

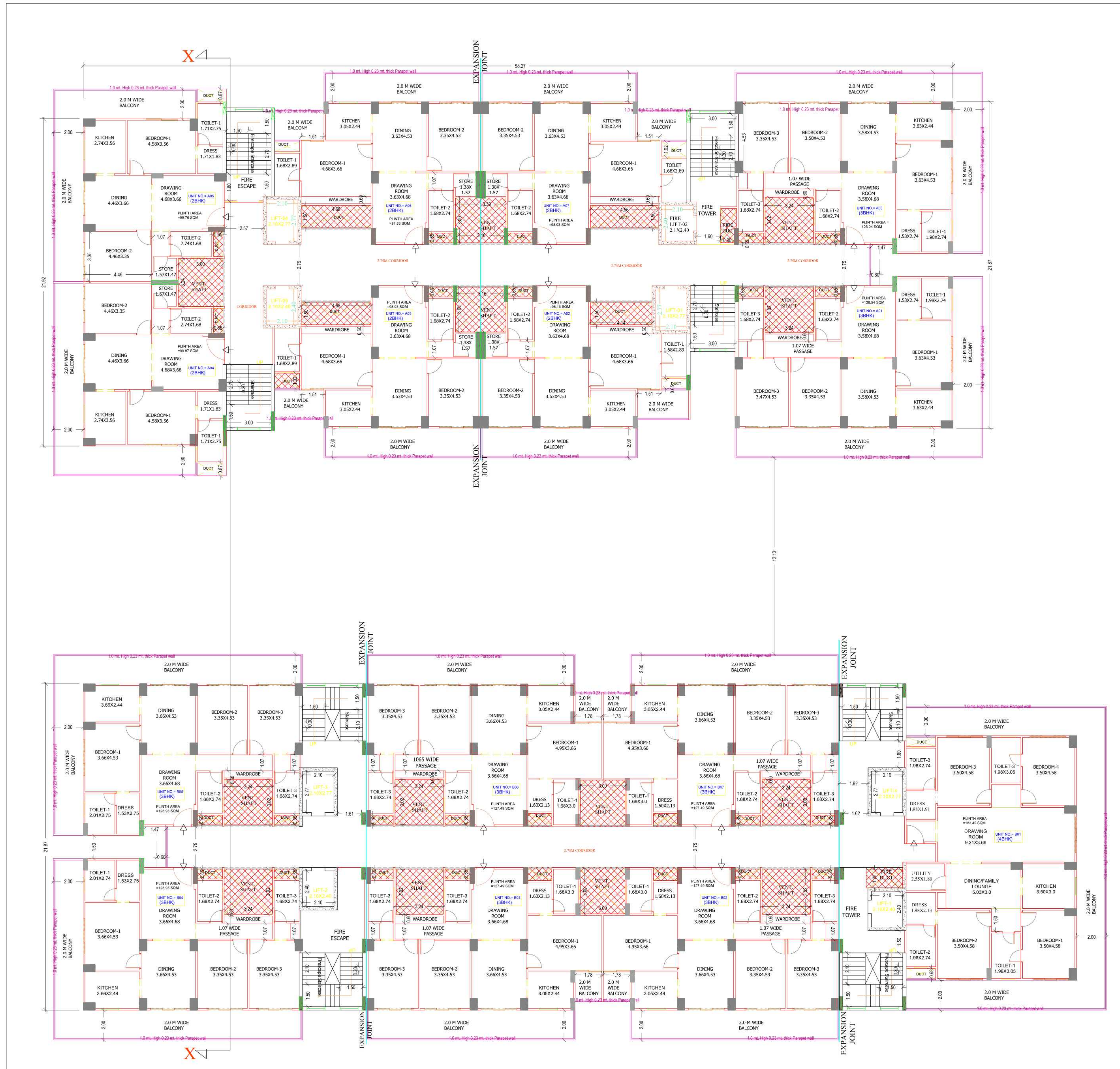

TYPICAL 2nd TO 10th FLOOR PLAN(BLOCK-A & B)



Citizen Housing
TWIN TOWERS

OWNER'S NAME AND SIGNATURE	
OWNERS- 1. DR. SHEO PRATAP SINGH S/O LATE BRAMH DEV SINGH 2. MR. RAHUL SINGH S/O DR. SHEO PRATAP 3. MR. ROHIT SINGH S/O DR. SHEO PRATAP DEVELOPER- CITIZEN INFRAVENTURES PRIVATE LIMITED THROUGH DIRECTOR MR. ANURAG VERMA.	
ARCHITECT'S NAME AND SIGNATURE	STRUCTURE ENGINEER
AKHILESHWAR SINGH CA/1994/16740	
	Prayagraj Development Authority
Building Plan Application Number	
Sanctioned On	
Valid Till	
Approved By	
Examined By	



Note: - 1) This drawing is prepared as per the current prevailing Building Bye Laws.
 2) If Map sanctioned is used for purpose anything other than stated in application will lead to rejection of Map.

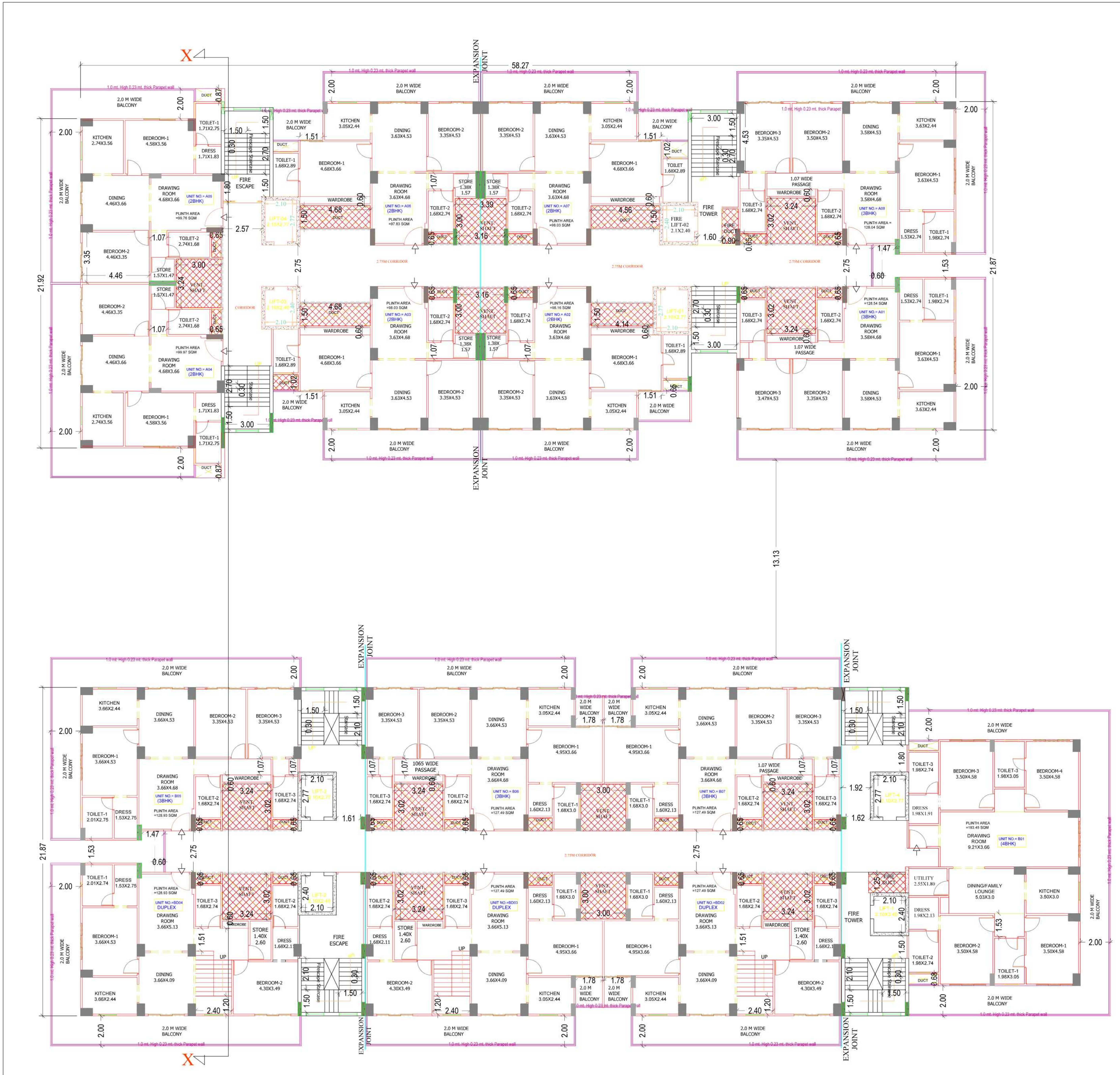

TYPICAL 11th,13th,15th FLOOR PLAN (BLOCK-A & B)



OWNER'S NAME AND SIGNATURE	
OWNERS- 1. DR. SHEO PRATAP SINGH S/O LATE BRAMH DEV SINGH 2. MR. RAHUL SINGH S/O DR. SHEO PRATAP 3. MR. ROHIT SINGH S/O DR. SHEO PRATAP DEVELOPER- CITIZEN INFRAVENTURES PRIVATE LIMITED THROUGH DIRECTOR MR. ANUBHAV VERMA.	
ARCHITECT'S NAME AND SIGNATURE	STRUCTURE ENGINEER
AKHILSHWAR SINGH CA/1994/16740	
Prayagraj Development Authority	
Building Plan Application Number	
Sanctioned On	
Valid Till	
Approved By	
Examined By	



Note: - 1) This drawing is prepared as per the current prevailing Building Bye Laws.
 2) If Map sanctioned is used for purpose anything other than stated in application will lead to rejection of Map.

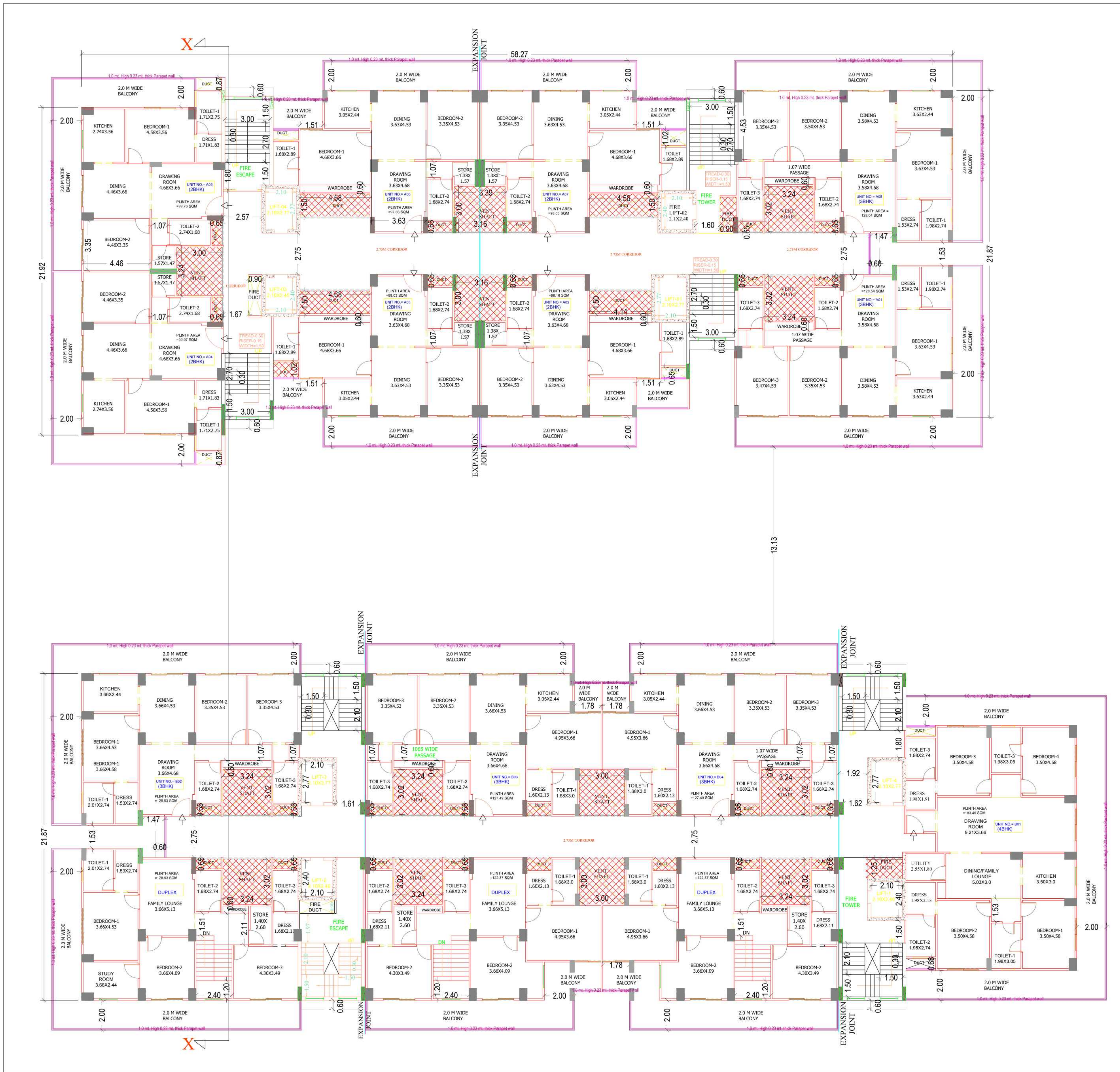

PROPOSED TYPICAL 12th,14th&16th FLOOR PLAN (BLOCK-A & B)



OWNER'S NAME AND SIGNATURE	
OWNERS- 1. DR. SHEO PRATAP SINGH S/O LATE BRAMH DEV SINGH 2. MR. RAHUL SINGH S/O DR. SHEO PRATAP 3. MR. ROHIT SINGH S/O DR. SHEO PRATAP DEVELOPER- CITIZEN INFRAVENTURES PRIVATE LIMITED THROUGH DIRECTOR MR. ANUBHAV VERMA.	
ARCHITECT'S NAME AND SIGNATURE	STRUCTURE ENGINEER
AKHILESHWAR SINGH CA/1994/16740	
	Prayagraj Development Authority
Building Plan Application Number	
Sanctioned On	
Valid Till	
Approved By	
Examined By	



Note: - 1) This drawing is prepared as per the current prevailing Building Bye Laws.
 2) If Map sanctioned is used for purpose anything other than stated in application will lead to rejection of Map.
 ISO_A0_(841.00_x_1189.00_MM)



THERE WILL BE PROVISION FOR PHOTO VOLTAIC POWER PLANT @ 1% OF TOTAL SANCTIONED LOAD.

TERRACE FLOOR PLAN (BLOCK-A & B)



OWNER'S NAME AND SIGNATURE	
OWNERS- 1. DR. SHEO PRATAP SINGH S/O LATE BRAMH DEV SINGH 2. MR. RAHUL SINGH S/O DR. SHEO PRATAP 3. MR. ROHIT SINGH S/O DR. SHEO PRATAP DEVELOPER- CITIZEN INFRAVENTURES PRIVATE LIMITED THROUGH DIRECTOR MR. ANURAG VERMA.	
ARCHITECT'S NAME AND SIGNATURE	STRUCTURE ENGINEER
AKHILESHWAR SINGH CA/1994/16740	
	Prayagraj Development Authority

Building Plan Application Number
Sanctioned On
Valid Till
Approved By
Examined By



Note: - 1) This drawing is prepared as per the current prevailing Building Bye Laws.
 2) If Map sanctioned is used for purpose anything other than stated in application will lead to rejection of Map.



SECTION-XX (BLOCK-A&B)



NORTHERN SIDE ELEVATION (BLOCK-A) SCALE=1:200

NORTHERN SIDE ELEVATION (BLOCK-B) SCALE=1:200



OWNER'S NAME AND SIGNATURE
 OWNERS:-
 1. DR. SHEO PRATAP SINGH S/O LATE BRAMH DEV SINGH
 2. MR. RAHUL SINGH S/O DR. SHEO PRATAP
 3. MR. RISHI SINGH S/O DR. SHEO PRATAP
 DEVELOPER:-
 CITIZEN INFRAVENTURES PRIVATE LIMITED THROUGH DIRECTOR
 MR. ANURAG VERMA.

ARCHITECT'S NAME AND SIGNATURE | STRUCTURE ENGINEER
 AKHILESHWAR SINGH
 CA/1994/16740

Prayagraj Development Authority

Building Plan Application Number

Sanctioned On

Valid Till

Approved By

Examined By



Note: - 1) This drawing is prepared as per the current prevailing Building Bye Laws.
 2) If Map sanctioned is used for purpose anything other than stated in application will lead to rejection of Map.

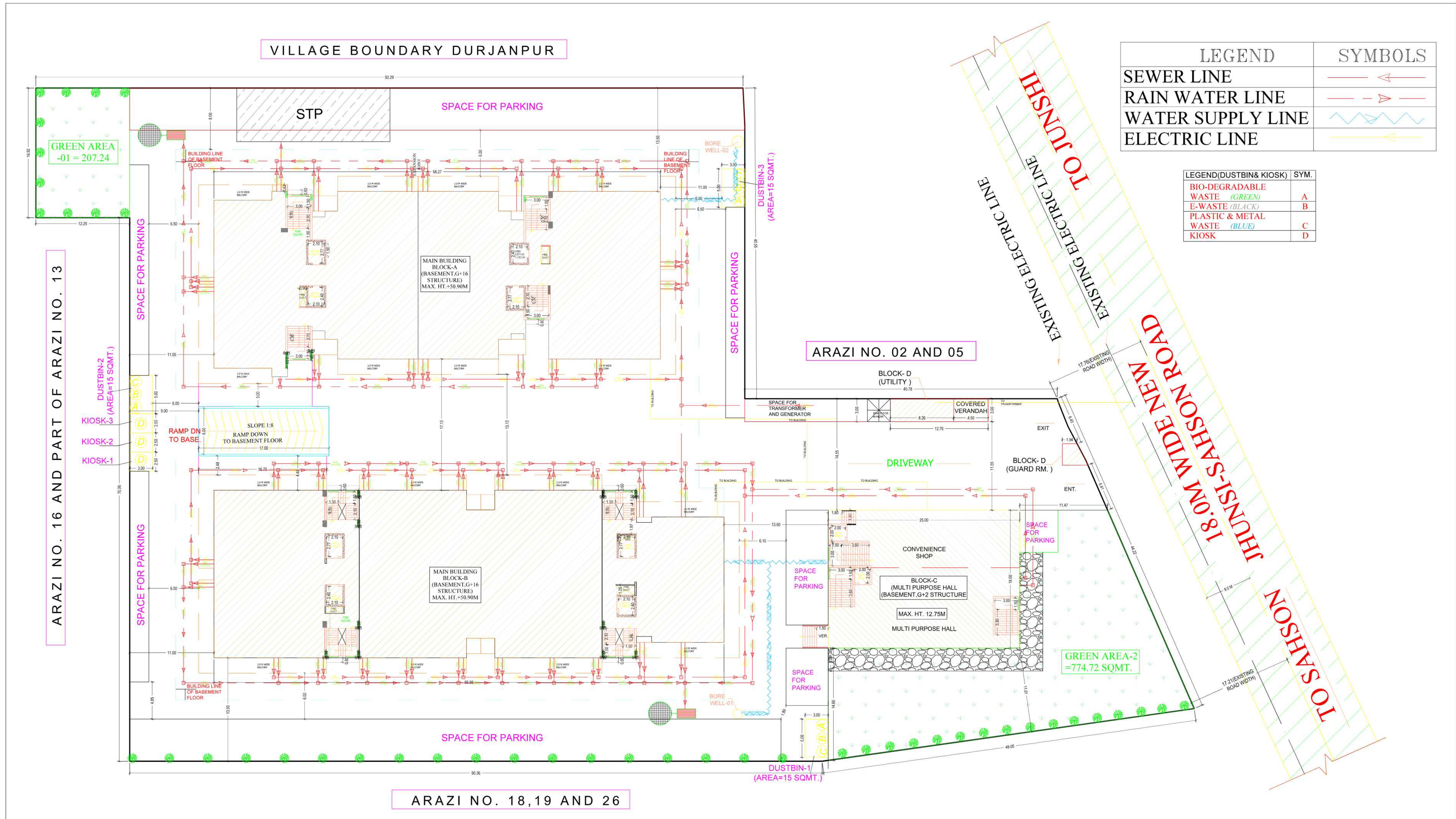

LEGEND	SYMBOLS
SEWER LINE	
RAIN WATER LINE	
WATER SUPPLY LINE	
ELECTRIC LINE	

LEGEND(DUSTBIN& KIOSK) SYM.	
BIO-DEGRADABLE WASTE (GREEN)	A
E-WASTE (BLACK)	B
PLASTIC & METAL WASTE (BLUE)	C
KIOSK	D



OWNER'S NAME AND SIGNATURE
 OWNERS:-
 1. DR. SHEO PRATAP SINGH S/O LATE BRAMH DEV SINGH
 2. MR. RAHUL SINGH S/O DR. SHEO PRATAP
 3. MR. ROHIT SINGH S/O DR. SHEO PRATAP
 DEVELOPER:-
 CITIZEN INFRAVENTURES PRIVATE LIMITED THROUGH DIRECTOR
 MR. ANUBHAV VERMA.

ARCHITECT'S NAME AND SIGNATURE | STRUCTURE ENGINEER
 AKHILESHWAR SINGH
 CA/1994/16740

Prayagraj Development Authority

Building Plan Application Number

Sanctioned On

Valid Till

Approved By

Examined By

**PROPOSED SITE PLAN
 WITH SERVICES
 SCALE=1:200**



Note: - 1) This drawing is prepared as per the current prevailing Building Bye Laws.
 2) If Map sanctioned is used for purpose anything other than stated in application will lead to rejection of Map.

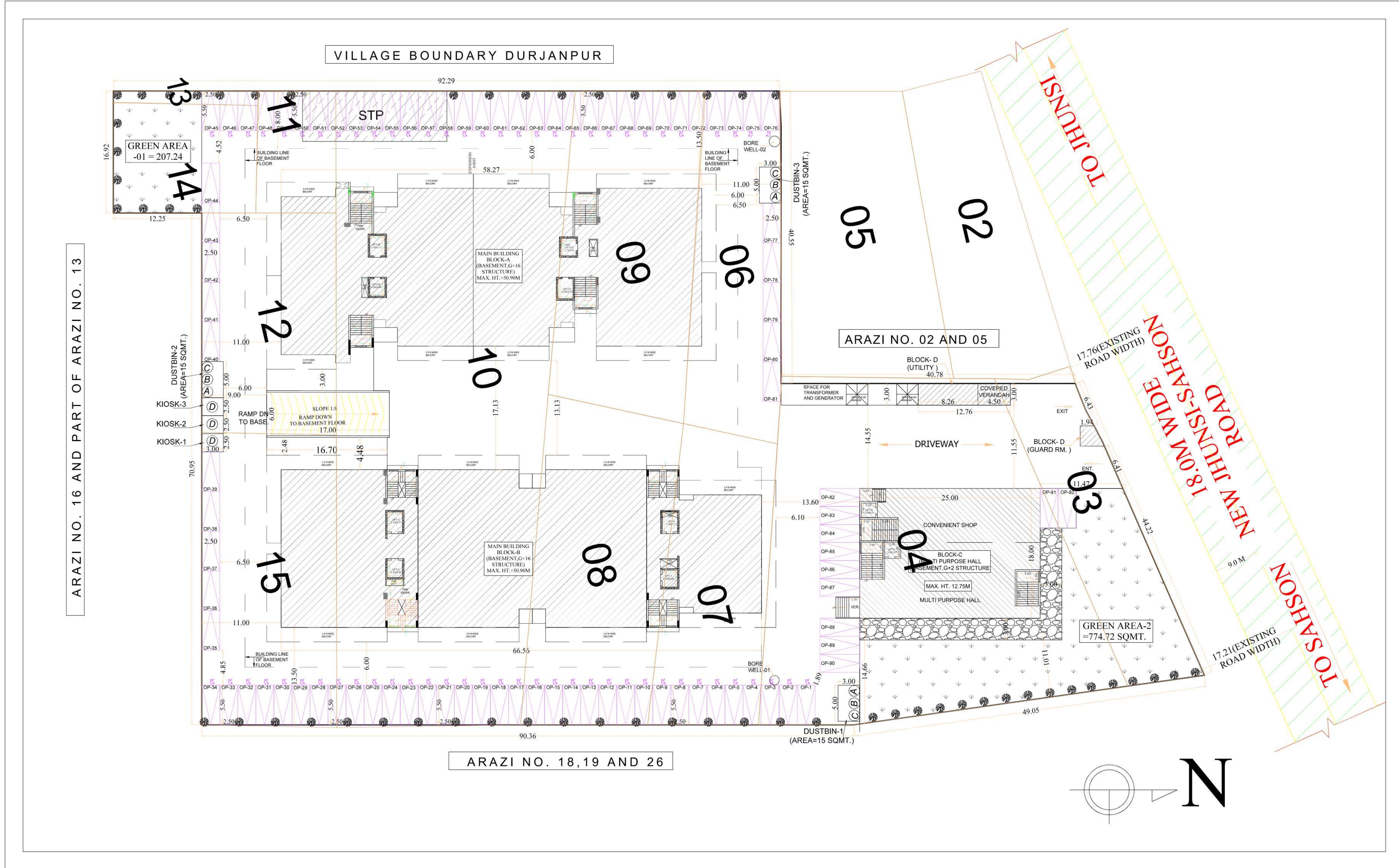

PROPOSED SITE PLAN



OWNER'S NAME AND SIGNATURE
 OWNERS:-
 1. DR. SHEO PRATAP SINGH S/O LATE BRAMH DEV SINGH
 2. MR. RAHUL SINGH S/O DR. SHEO PRATAP
 3. MR. ROHIT SINGH S/O DR. SHEO PRATAP
 DEVELOPER:-
 CITIZEN INFRAVENTURES PRIVATE LIMITED THROUGH DIRECTOR
 MR. ANUBHAV VERMA.

ARCHITECT'S NAME AND SIGNATURE STRUCTURE ENGINEER
 AKHILESHWAR SINGH
 CA/1994/16740

Prayagraj Development Authority

Building Plan Application Number

Sanctioned On

Valid Till

Approved By

Examined By



Note: - 1) This drawing is prepared as per the current prevailing Building Bye Laws.
 2) If Map sanctioned is used for purpose anything other than stated in application will lead to rejection of Map.