





**PHE LEGEND**

	MWS	MUNICIPAL WATER SUPPLY
	SP	SEWAGE PIPE
	RWP	RAIN WATER PIPE
	WSVC	1200x900MM WIDE WATER SUPPLY VALVE CHAMBER
	RPP	RAINWATER PERCOLATION PIT



**KEY PLAN**

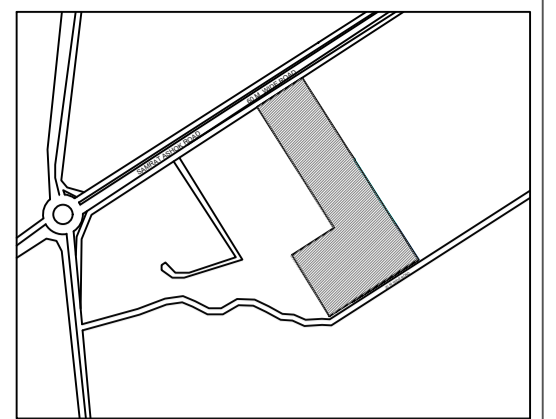
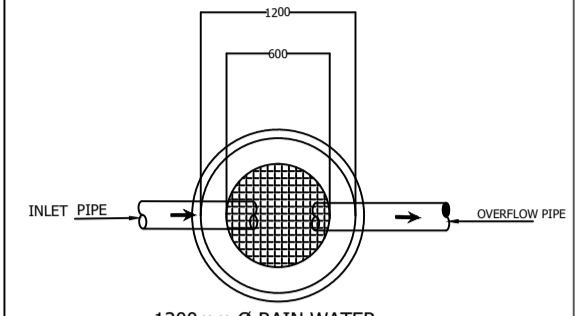

**1200mm Ø RAIN WATER PERCOLATION PIT (SCALE : NTS)**

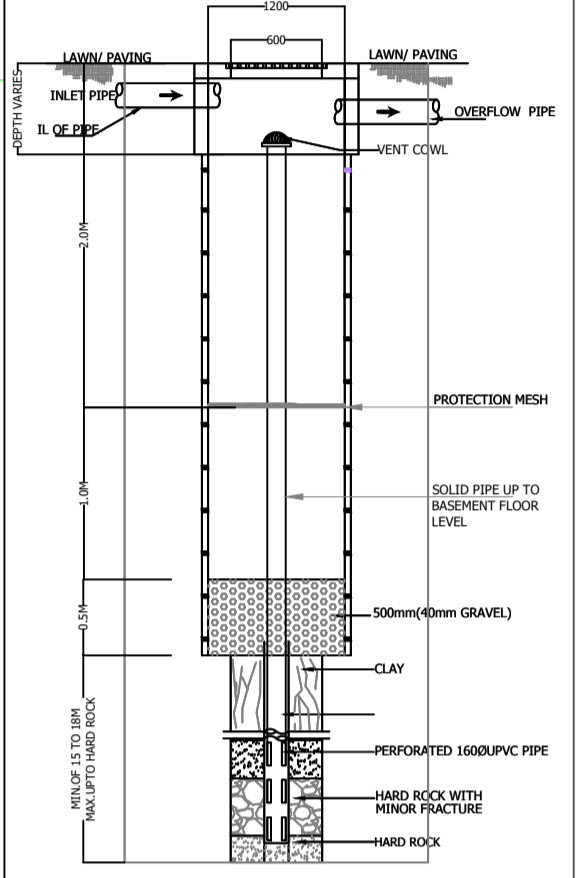

**SECTIONAL DETAIL (SCALE: NTS)**

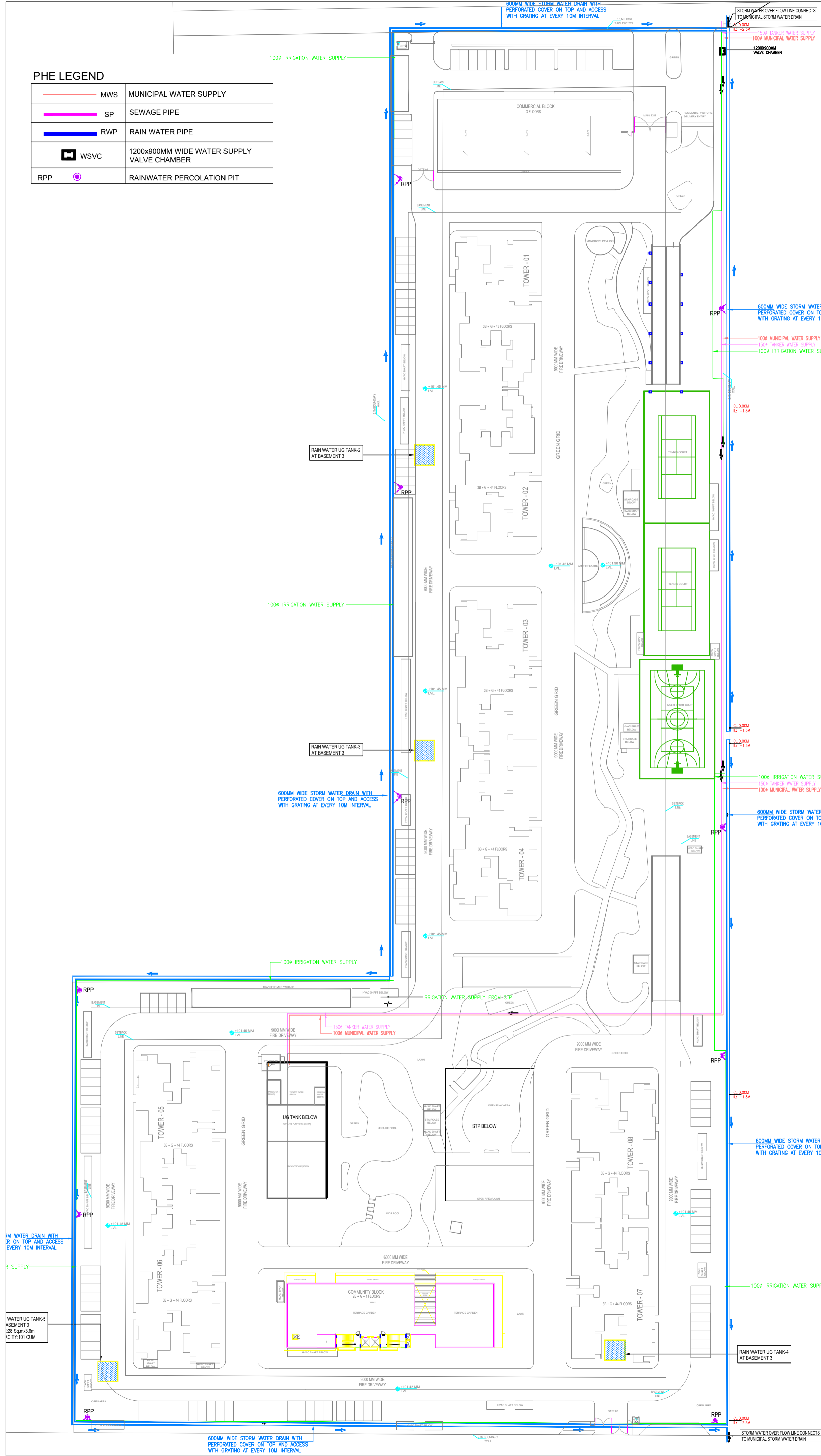

Rev	Description	Date	Issued by

**M/S ATLASPUR CONSTRUCTION & DEVELOPERS PVT.LTD AND M/S SOBHA LTD**

**PROJECT**  
PROPOSED RESIDENTIAL DEVELOPMENT, GH-12, SECTOR 01, GREATER NOIDA

**TITLE**  
WATER SUPPLY PLAN

<b>OWNERS SIGN</b> DIVYA PRAKASH	<b>ARCHITECTS SIGN</b> SHIVAN G BANSAL
-------------------------------------	---

PROJECT CODE 0472	RELEASED FOR HCR	SCALE 1:500	SHEET A0
NORTH	DRAWING NO. PE -101	DATE 02.02.2026	REVISION R0